

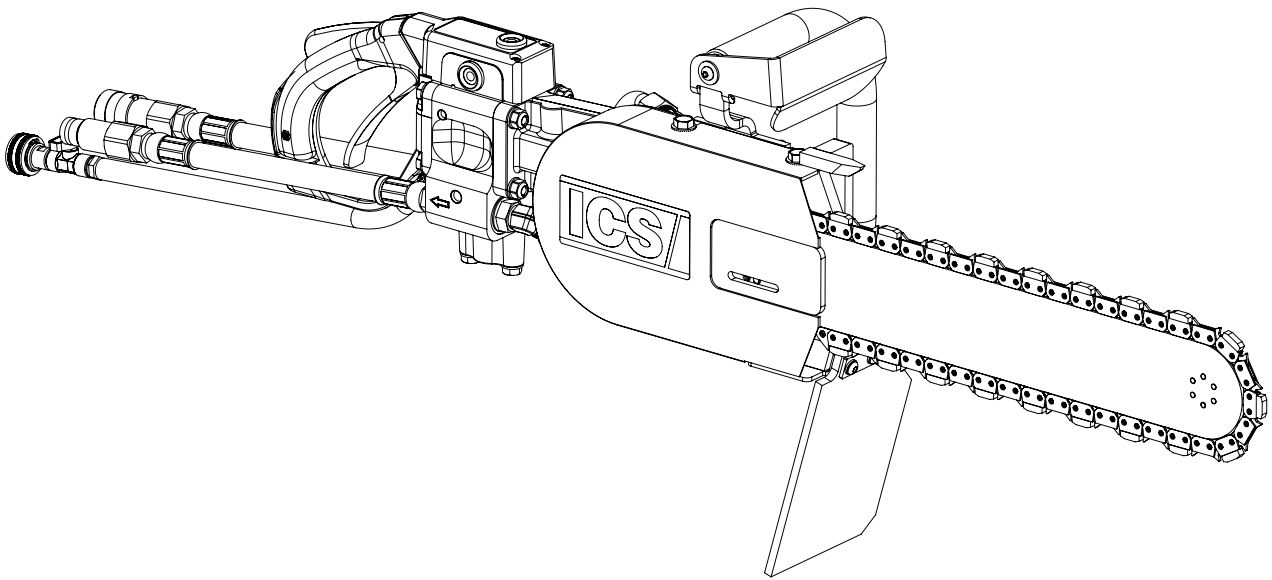

Diamond Tools and Equipment
for Construction and Infrastructure

Replacement Parts & Accessories Price List



880/890 FLUSH Series Hydraulic Concrete Saw

Effective January 1, 2017

TABLE OF CONTENTS

880/890 FLUSH Series Hydraulic Concrete Saw

ITEM DESCRIPTION	KEY	PAGE
880/890 FLUSH Series Hydraulic Saw Service Parts & Kits	n/a	2
880/890 FLUSH Series Hydraulic Saw Assembly	B	3-4

SERVICE PARTS & KITS

880/890 FLUSH Series Hydraulic Concrete Saw

Part No.	Description	MSRP
70619	880/890 FLUSH Series Tensioning Screws, Hydraulic Saws	\$13.00
71526	880/890 FLUSH Series Hydraulic Valve Spool Kit	\$87.00
72296	880/890 FLUSH Series Hydraulic Valve Seal Kit	\$28.00
72347	880/890 FLUSH Series Hydraulic Trigger Lock-Out Spring & Pin Kit	\$24.00
506026	880/890 FLUSH Series Hydraulic Trigger & Lock-Out Kit	\$39.00
507407	880/890 FLUSH Series Hydraulic Front Handle Fastener Kit	\$13.00
518869	880/890 FLUSH Series Hydraulic Water Valve Kit, includes clip, plunger, spring, ball & water bridge spindle	\$105.00
528594	880/890 FLUSH Series Motor Seal Kit	\$170.00
72342	880/890 FLUSH Series Hydraulic Motor Bolt Kit	\$23.00
565317	880/890 FLUSH Series Valve Cover with levels	\$107.00
72344	880/890 FLUSH Series Valve Bolt Kit	\$25.00
530046	880/890 FLUSH Series FORCE4™ Bar Nose Sprocket Repair Kit	\$40.51
566059	880/890 FLUSH Series Water Shut-off Valve Kit	\$66.00
564984	880/890 FLUSH Series Motor Conversion Kit with sprocket 8 gpm	\$747.00
564985	880/890 FLUSH Series Motor Conversion Kit with sprocket 12 gpm	\$747.00

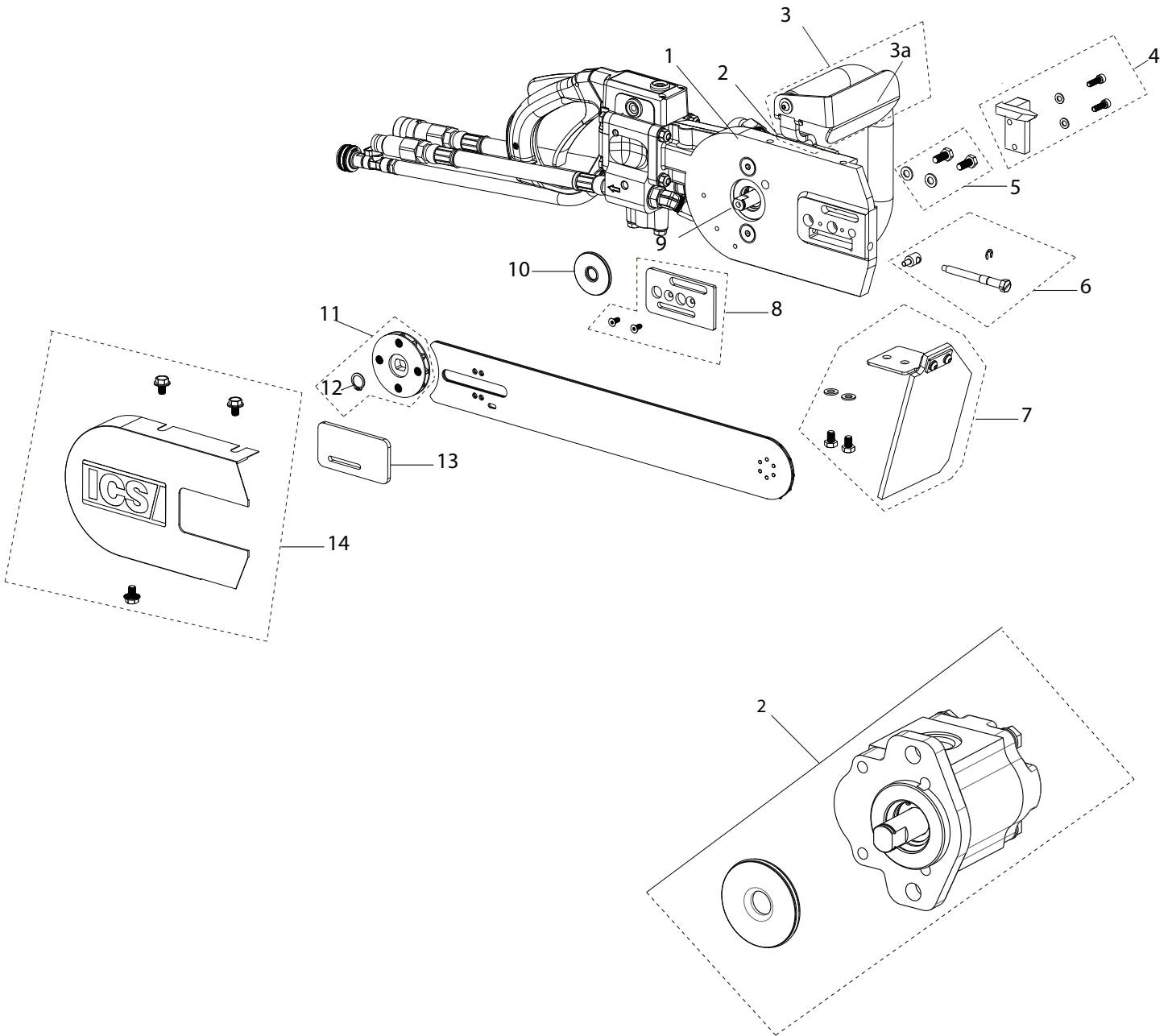

Key #	Part No.	Description	MSRP
1	532512	880/890 FLUSH Series Mainframe Replacement Kit	\$348.00
2	564962	880/890 FLUSH Series Replacement Motor Kit 30 lpm	\$587.00
2	564983	880/890 FLUSH Series Replacement Motor Kit 45 lpm	\$587.00
3	523947	880/890 FLUSH Series Front Handle Kit (includes 3a) 30 lpm	\$198.00
3a	74586	880/890 FLUSH Series Front Handguard Kit 30 lpm	\$37.00
3	567102	880/890 FLUSH Series Front Handle Kit (includes 3a) 45 lpm	\$198.00
3a	517874	880/890 FLUSH Series Front Handguard Kit 45 lpm	\$37.00
4	524673	880/890 FLUSH Series WallWalker Spike Kit	\$234.00
5	524658	880/890 FLUSH Series Bar Clamp Bolt Kit	\$17.00
6	523946	880/890 FLUSH Series Tensioner Kit	\$54.00
7	576682	880/890 FLUSH Series Guard Flap Assembly Kit	\$59.00
8	523945	880/890 FLUSH Series Spacer Plate Kit	\$310.00
9	564923	880/890 FLUSH Series Shaft Conversion Kit w/Motor Seals 30 lpm	\$347.00
9	564924	880/890 FLUSH Series Shaft Conversion Kit w/ Motor Seals 45 lpm	\$347.00
10	528563	880/890 FLUSH External Shaft Seal	\$58.00
11	565066	880/890 FLUSH Series Drive Sprocket Kit (includes Snap ring) 30 lpm/45 lpm	\$230.00
12	549796	880/890 FLUSH Series Snap ring Kit	\$5.00
13	524657	880/890 FLUSH Series Bar Clamp Plate Kit	\$115.00
14	532515	880/890 FLUSH Series Side Cover Kit	\$319.00
		* All other replacement parts are the same as 880/890 Series	
		**Replacement parts for Trigger are listed on page 2	

880/890 FLUSH Series Replacement Parts & Accessories Price List

**ICS, Blount Inc.
4909 SE International Way
Portland, OR 97222 USA
800.321.1240
icsdiamondtools.com**